

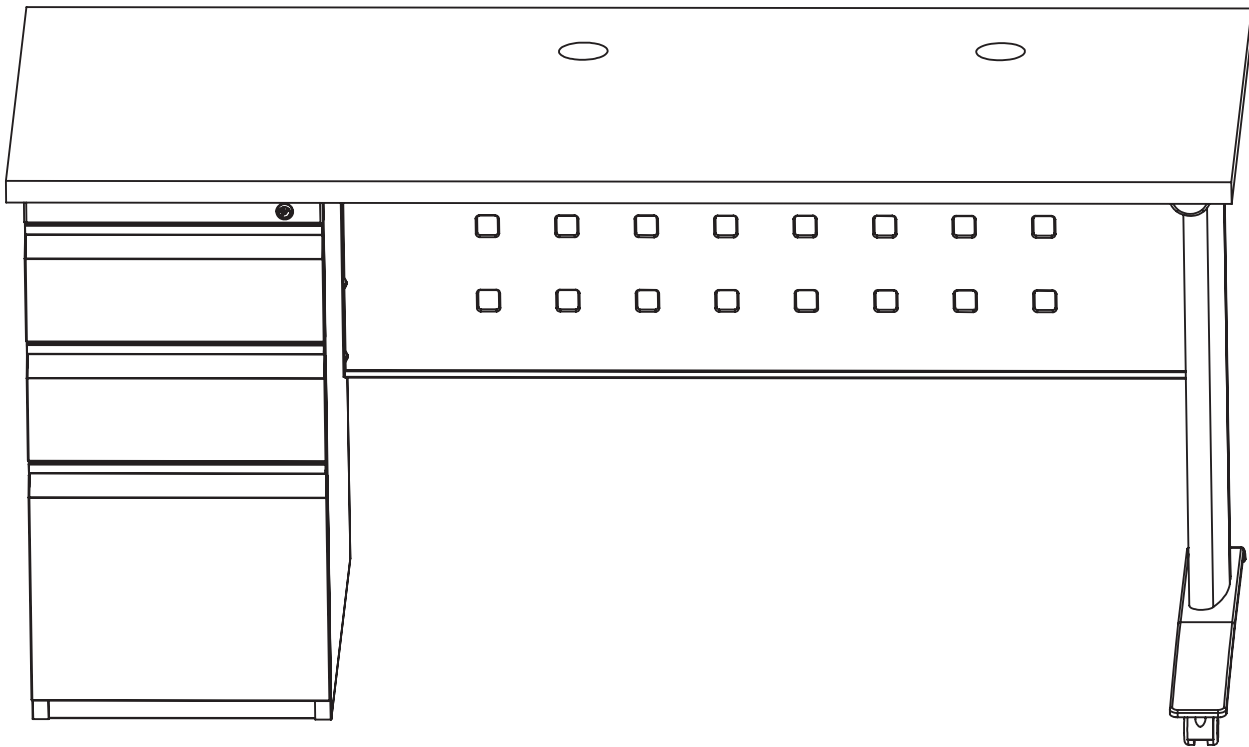

R-Style Custom C Leg Base with Side Stationary Pedestal Assembly Instructions

Warranty: raproducts.com/warranty



Tools Required for Assembly

- A. Power Driver with Adjustable Torque
- B. #2 Phillips Head Driver Bit
- C. #2 Square Head Drive Bit

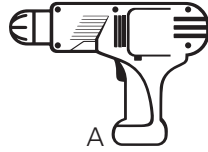

Hardware Included for Assembly *(may have extra)*

- D. M6 x 15 Phillips Head Machine Screw x6
- E. 10 x 5/8" Wood Screw x12

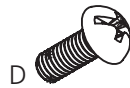

Parts

- F. Right Leg x1
- G. Modesty Panel x1
- H. Pedestal x1

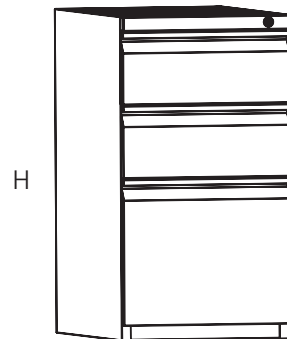
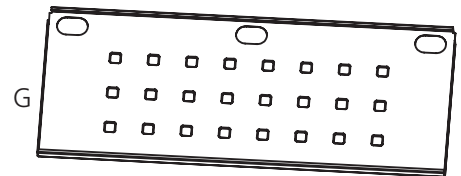
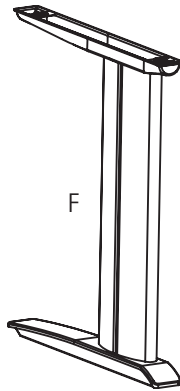

Step 1

- Lay the worksurface on a protected surface with the pilot holes facing up.

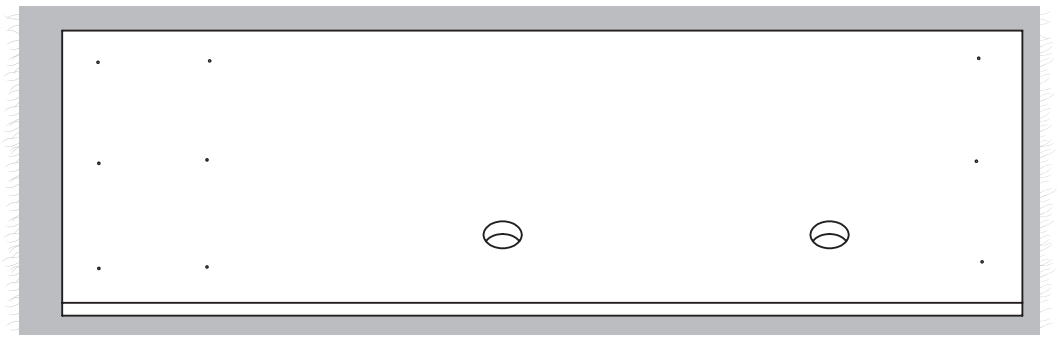

Step 2

- Attach the modesty panel to the leg with three machine screws and fully tighten.

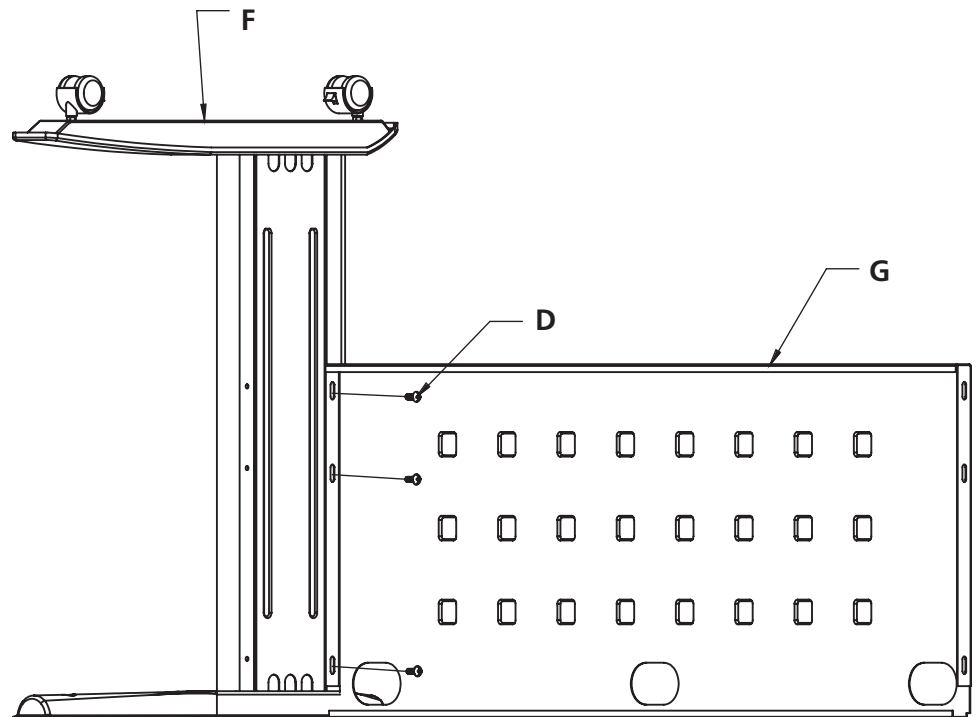
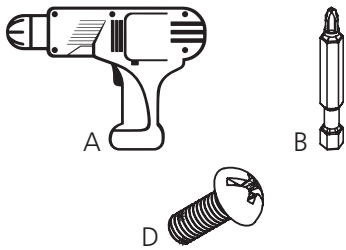

Step 3

- Attach the modesty panel to the pedestal with three machine screws and fully tighten.

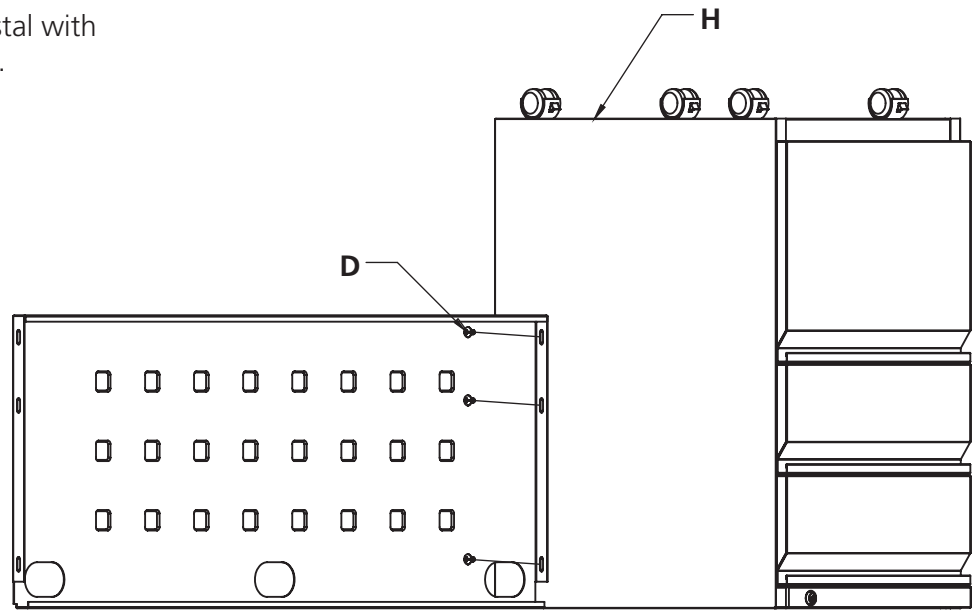
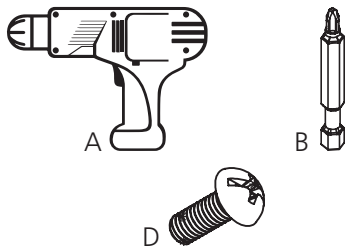

Step 4

- Attach the leg to the worksurface with three screws. Pilot holes are provided.

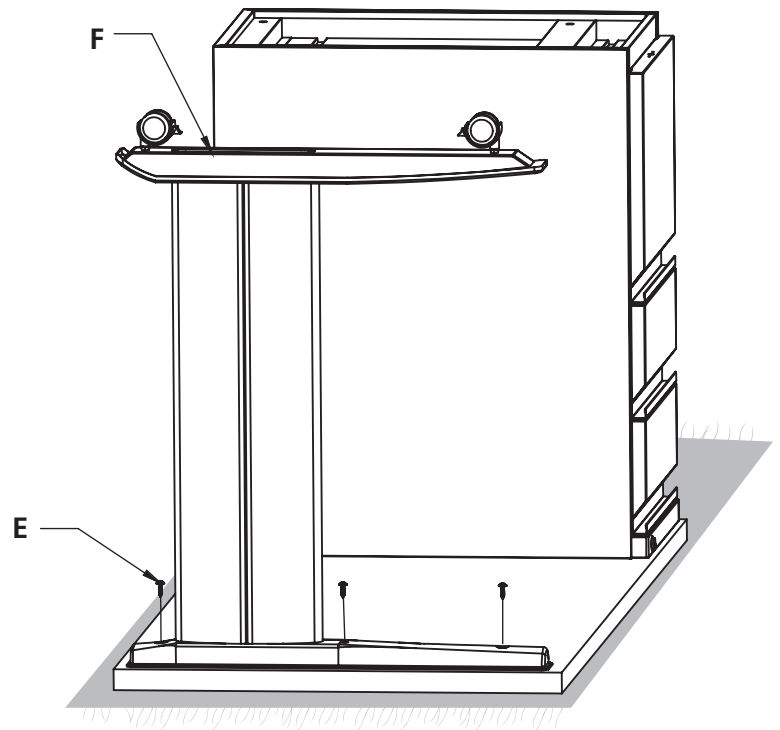
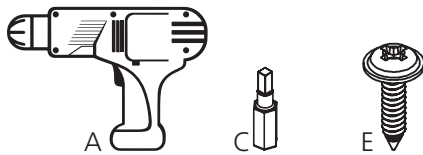

Step 5

- Slide the drawers out of the pedestal.
- Attach the pedestal to the worksurface with six wood screws. Pilot holes are provided.

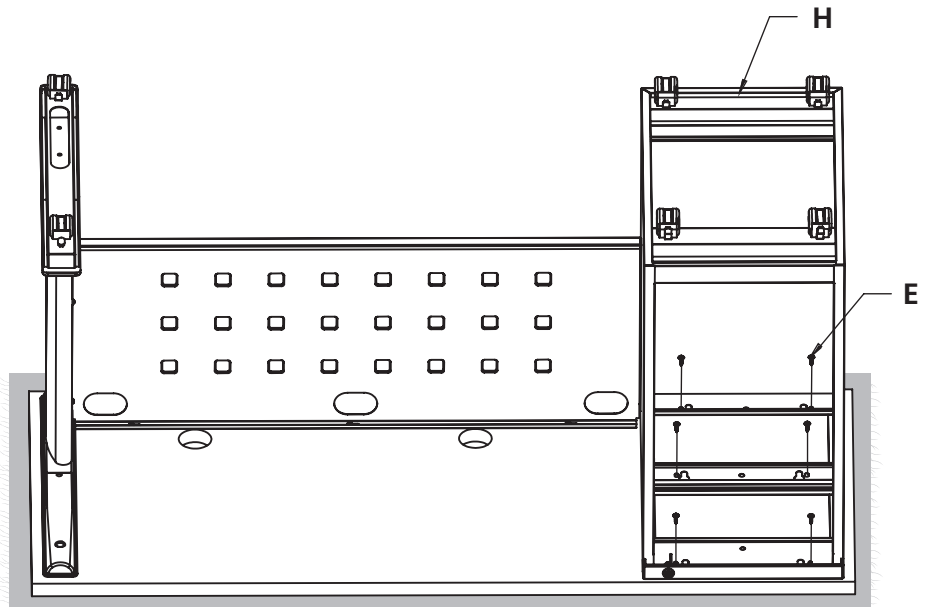
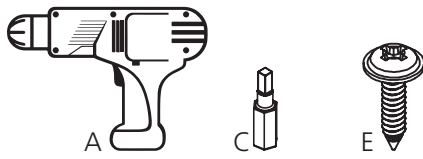

Step 6

- Attach the modesty panel to the worksurface with three wood screws. Pilot holes are NOT provided. Screws are self driving

