

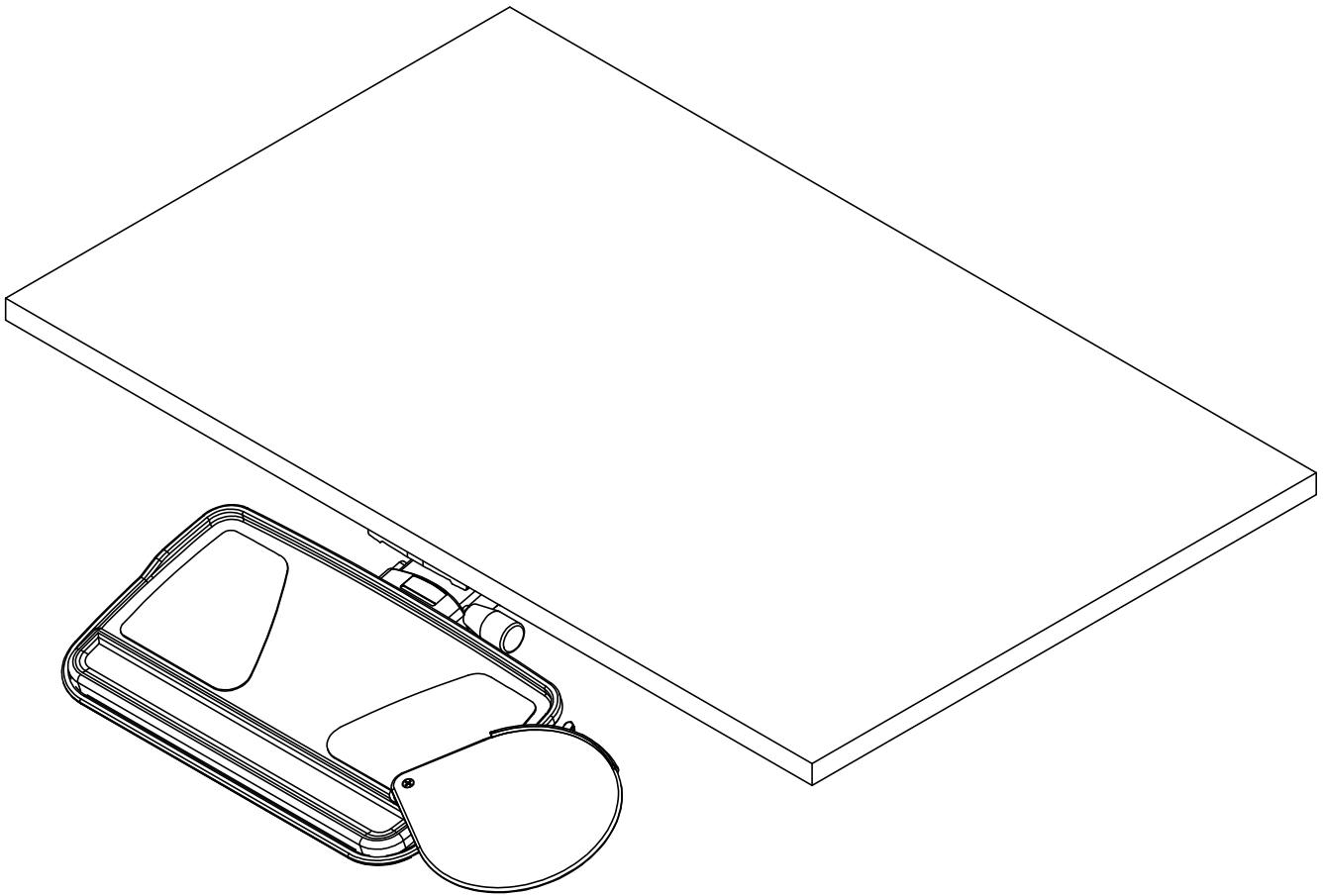

**2000EM Over C-bracket Myriad Assembly Instructions**  
**Warranty: [raproducts.com/warranty](http://raproducts.com/warranty)**





Power Driver with Adjustable Torque



#2 Phillips Head Driver Bit



or Phillips Screwdriver



7/16" Wrench, Socket, or Driver Bit

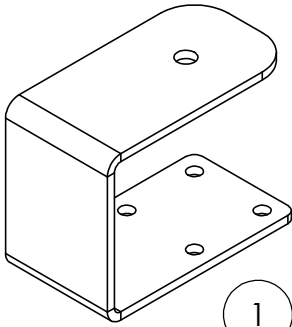

800445 x1

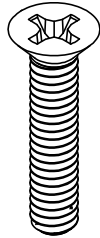

50049 x1

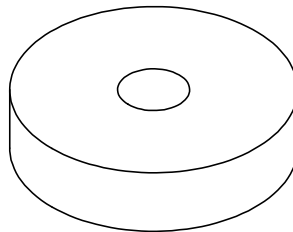

50733 x1

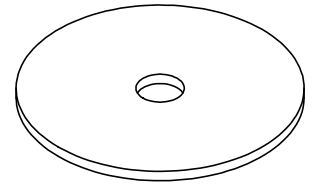

50201 x1  
(Nylon)

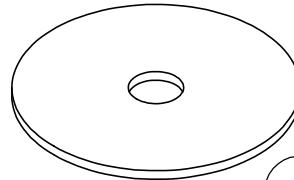

50153 x1  
(Steel)

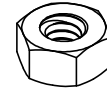

52085 x1



50805 x4

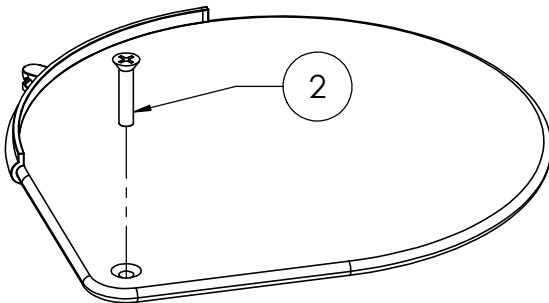

Build this as a subassembly.

